

INTEΨA



UV-I-UNIT016W



UV-I-UNIT030W / UV-I-UNIT055W



UV-I-UNIT110W



UV-I-UNIT220W

UV Systems

Assembly and Operating Instructions

Water we're in our Element

Table of Contents

1. General Information	2
2. Safety Precautions	2
3. Dimensioning	4
3.1 <i>Service Life</i>	4
3.2 <i>Operating Range and Dimensioning</i>	4
4. Deliverables	5
5. Technical Data	6
6. Assembly Instructions	8
7. Maintenance and Cleaning	11
8. Replacement Parts	12
9. Warranty / Contact	13

1. General Information

Thank you for choosing an INTEWA UV system! Please read the operating instructions carefully before commissioning to ensure safe and correct system startup.

The INTEWA UV systems are based on UV-C radiation water disinfection systems that inactivate microorganisms. The UV radiation is generated with a low-pressure mercury lamp, whose maximum intensity is at a wavelength of approximately 254nm. Microorganisms, such as bacteria and viruses, during irradiation at this wavelength lose the ability of cell division and are thus inactivated.

2. Safety Precautions



This product works with UV radiation, which can cause permanent damage to skin and eyes!

!! The UV lamp should therefore never be operated without special protective measures (UV impenetrable protective clothing and eye protection) outside the reactor!



The reactor heats up with stagnant water flow. This heat must be dissipated in order to ensure reliable operation. Therefore, do NOT insulate the reactor vessel. Due to heat, the water in the reactor expands. Therefore, an expansion tank must be installed in the pipe system. For rigid metal conduit we recommend for additional security, a pressure relief valve (8 bar).

The system must be protected from direct sunlight and weather.

If the mercury vapor lamp breaks, the room must be vacated immediately and thoroughly ventilated for at least 30 minutes. Subsequently, the glass can be disposed of.



Electrical components may only be installed by a licensed electrician. In case of malfunction of the electrical equipment, the product may only be put back into service after it has been repaired by a qualified electrician. There is a danger of electric shock!

The socket used for the device must be protected by a circuit breaker (in many countries 16 A). Similarly, a Ground Fault Interrupter upstream with a maximum operating current of 30 mA, when a circuit breaker is not available.



Before installing the product, these installation and operating instructions must be read carefully. The indicated instructions herein must be strictly observed. Modifications to the product are not permitted, otherwise any warranty expires.

The following points must be adhered to for the installation and operation:

- Inspect the product before installation for any visible defects. If defects are present, the product may not be installed. Damaged products can be dangerous.
- Installations on drinking water supply network must be carried out by an approved electrical installer.
- Near the installation location, a floor drain must be provided (ie. for pump defects, line breaks, etc.) that can drain accidental water leakage and prevent water damage in the building.
- The masonry behind a water-transport system must be protected against water damage (eg. water-resistant paint).
- Ensure that existing emergency overflows are connected and adequately dimensioned.
- Disconnect the power, if you are more than 24 hours away.
- Close the drinking water line before the device if you are more than 24 hours away.
- All products must be checked regularly for proper condition. The minimum inspection intervals are provided in the maintenance instructions.
- Electrical equipment can be dangerous for children. It is therefore necessary to keep children away from the product. Do not allow children to play with the product.
- Never install water-bearing products in locations where the temperature may drop below 0°C.
- Do not install electrical products in areas at risk of flooding.
- The operator is responsible for compliance with safety and installation requirements.

3. Dimensioning

3.1 Service Life

The service life of the UV lamp is approximately 9000 hours (= approx. 1 year). After this, they must be replaced.

Switching the system on/off leads to excessive wear of the electrode and to a significant reduction in service life. Therefore, continuous operation of UV systems is recommended.

If the lamp is operated discontinuously, take the following service lives into account and adapt the replacement interval of the lamp accordingly.

Switching frequency per day	Average service life	
0-2	9000 h	100%
3-4	6300 h	70%
5-6	4500 h	50%
> 6	900 h	10%

Note:

Overall, only about 1000 switching operations of the lamp are possible because for each ignition part of the electrode material evaporates and condenses on the interior lamp walls.

During discontinuous use, note that the full intensity UV radiation is available only after a few minutes!

3.2 Operating Range and Dimensioning

Depending on the application, different doses of radiation are required.

	UV-I-UNIT 016W	UV-I-UNIT 030W	UV-I-UNIT 055W	UV-I-UNIT 110W	UV-I-UNIT 220W
Maximum flow rate with radiation dose: 400 J/m ² - Drinking water, Europe - Greywater disinfection - Clarified outlet water	8 l/min	30 l/min	50 l/min	90 l/min	180 l/min
Maximum flow rate with radiation dose: 300 J/m ² - Drinking water, USA	9 l/min	38 l/min	62 l/min	105 l/min	205 l/min
Maximum flow rate with radiation dose: 250 J/m ² - Poolwater disinfection - Fish pond	10 l/min	45 l/min	70 l/min	129 l/min	268 l/min
Maximum flow rate with radiation dose: 150 J/m ² - Aquaculture	15 l/min	65 l/min	96 l/min	180 l/min	353 l/min

Note: Values for UV transmission $T(1\text{cm}) = 95\%$

Table: UV unit size as a function of flow rate and radiation flux

4. Deliverables

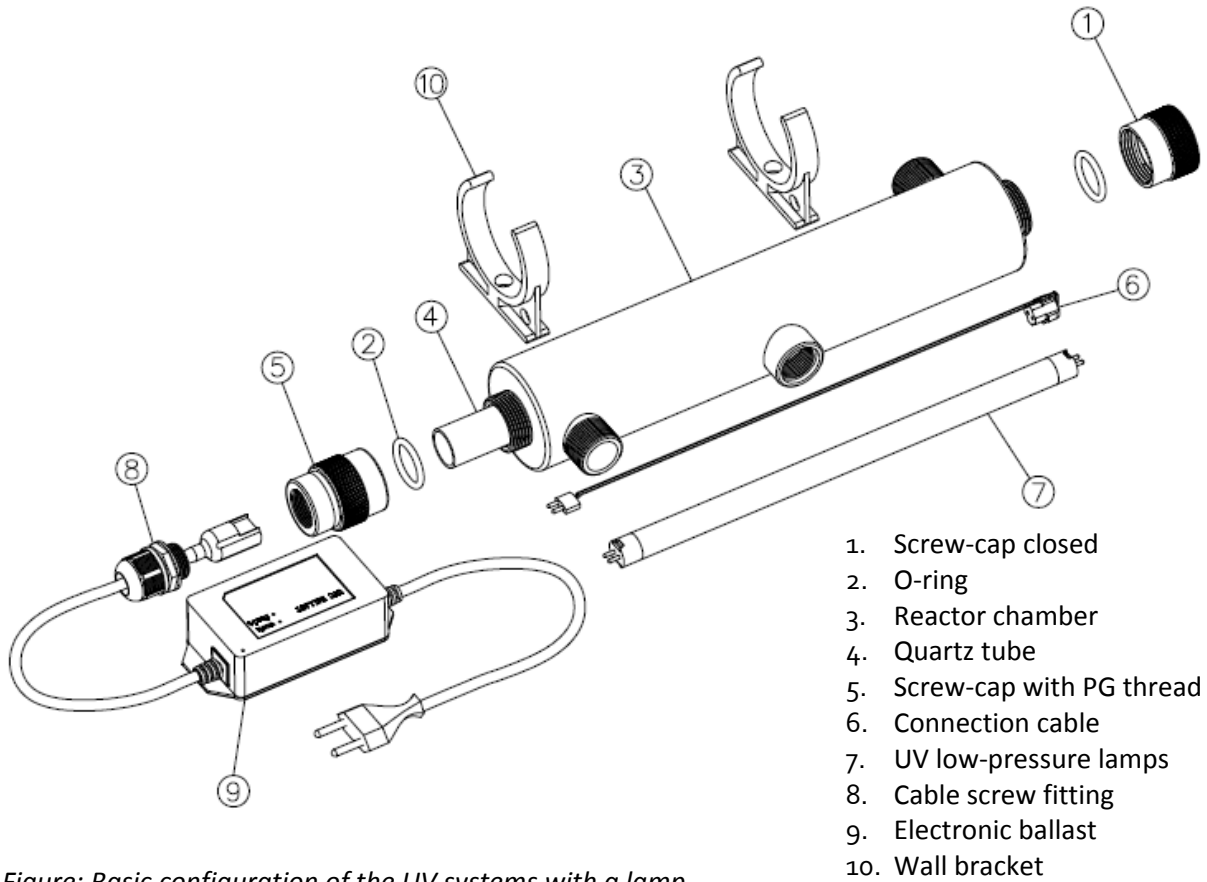

Figure: Basic configuration of the UV systems with a lamp

	UV-I-UNIT 016W	UV-I-UNIT 030W	UV-I-UNIT 055W	UV-I-UNIT 110W	UV-I-UNIT 220W
Reactor chamber	1 pcs.	1 pcs.	1 pcs.	1 pcs.	1 pcs.
Quartz glass	1 pcs.	1 pcs.	1 pcs.	2 pcs.	4 pcs.
O-ring	2 pcs.	2 pcs.	2 pcs.	4 pcs.	8 pcs.
Screw-cap	1 pcs.	1 pcs.	1 pcs.	1 pcs.	1 pcs.
Screw-cap open	1 pcs.	1 pcs.	1 pcs.	1 pcs.	1 pcs.
UV lamps	1 pcs.	1 pcs.	1 pcs.	2 pcs.	4 pcs.
Electronic ballast	1 pcs.	1 pcs.	1 pcs.	2 pcs.	4 pcs.
Wall bracket	2 pcs.	2 pcs.	2 pcs.	Integrated	Integrated
Protective gloves	1 pcs.	1 pcs.	1 pcs.	1 pcs.	1 pcs.

Table: Deliverables for UV units

5. Technical Data

	INTEWA UV Units				
Art. Code	UV-I-UNIT 016W	UV-I-UNIT 030W	UV-I-UNIT 055W	UV-I-UNIT 110W	UV-I-UNIT 220W
Power supply	230 V AC 50-60 Hz	230 V AC 50-60 Hz	230 V AC 50-60 Hz	230 V AC 50-60 Hz	230 V AC 50-60 Hz
Power consumption	21 W	40 W	72 W	144 W	288 W
Lamp wattage	16 W	30 W	55 W	110 W	220 W
UV-C power	3,4 W	12 W	17,5 W	35 W	70 W
Operating pressure max.	8 bar	8 bar	8 bar	8 bar	8 bar
Service life UV lamp	9000 h	9000 h	9000 h	9000 h	9000 h
Control incl. error display	ja	ja	ja	ja	ja
Reactor material	V2A	V2A	V2A	V2A	V2A
Ambient temperature max.	40°C	40°C	40°C	40°C	40°C
Water temperature max.	60°C	60°C	60°C	60°C	60°C
Number lamps / quartz glass	1	1	1	2	4
Quartz glass diameter	23 mm	34 mm	34 mm	34 mm	34 mm
Reactor length	350 mm	945 mm	945 mm	945 mm	945 mm
Reactor diameter	63,5 mm	63,5 mm	63,5 mm	108 mm	133 mm
Reactor height with bracket	83,5	83,5	83,5	158	183
Connection inlet / outlet	3/4" AG	1" AG	1" AG	1 ½ " AG	1 ½ " AG
Weight	1,8 kg	2,8 kg	2,9 kg	5,4 kg	8,5 kg
UV sensor connection	--	--	--	1" IG	1" IG

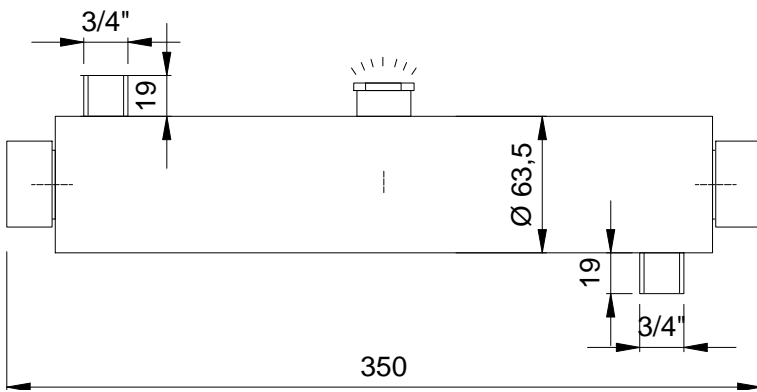

Figure: Dimensions UV-I-UNIT 016W

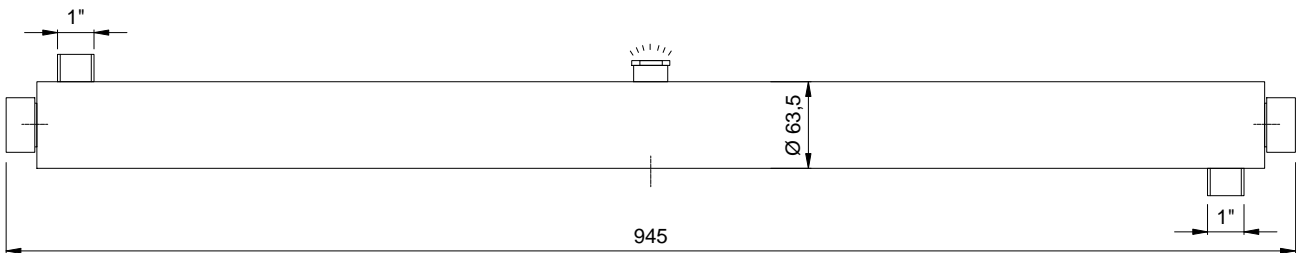

Figure: Dimensions UV-I-UNIT 030W, UV-I-UNIT 055W

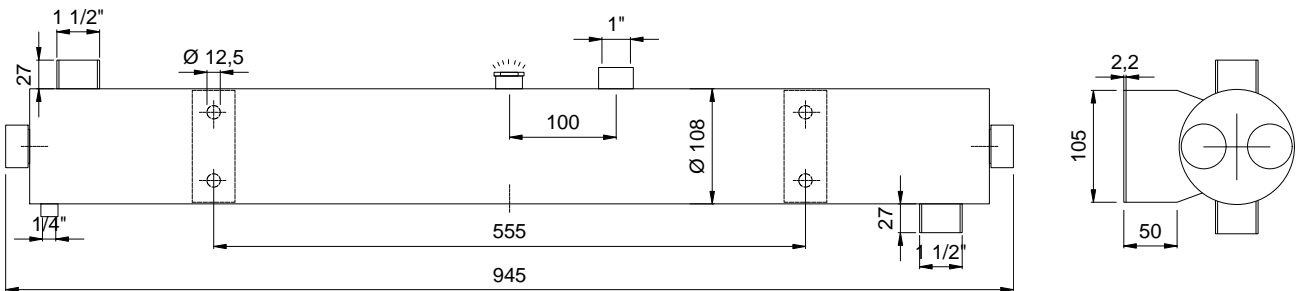

Figure: Dimensions UV-I-UNIT 110W

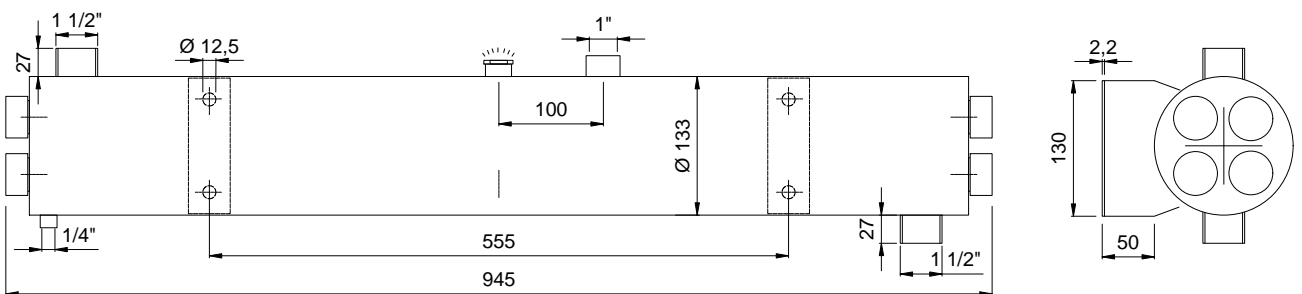

Figure: Dimensions UV-I-UNIT 220W

6. Assembly Instructions

1.
Before installation, the quartz glass and UV lamps must be cleaned to remove dirt and grease. Use alcohol (isopropanol) and accompanying protective gloves to avoid fingerprints.



2.
Slide an O-ring about 12mm over the open end of the quartz glass. (Avoid twisting the O-ring!)



3.
Run the quartz glass **carefully** into the reactor chamber, so that the closed end projects out the other side of the reactor. Slide the second O-ring on the closed end of the quartz glass.



-
4.
Mount the open screw-cap on the side with the open end of the quartz glass and the screw-cap on the closed end of the quartz glass.

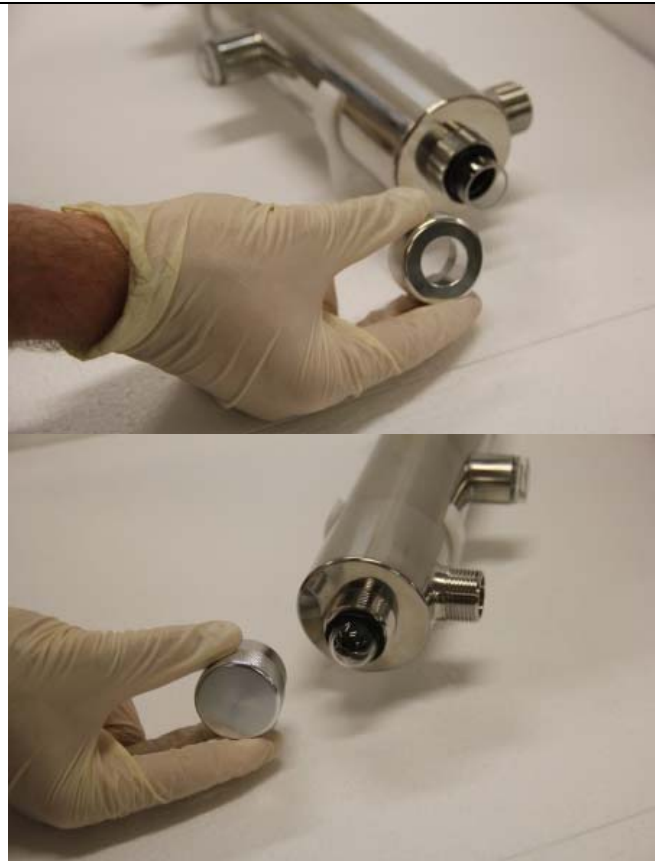

5.
Connect the electrical contacts on the UV lamp.

!! Attention!! The lamp cannot be connected to the main electrical grid! Only when it is in the reactor vessel and the cap is installed, can the lamp be put into operation!

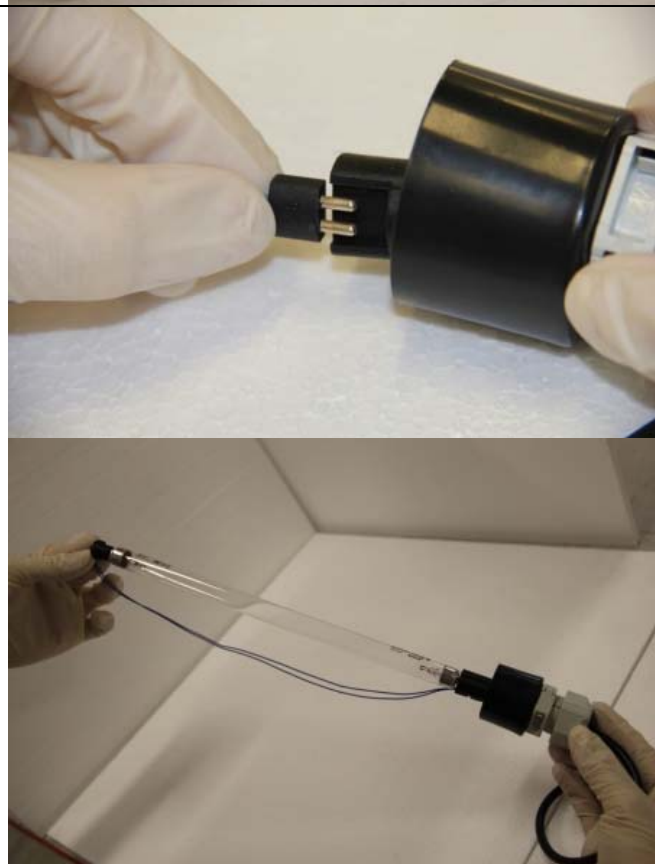

6.
Carefully slide the UV lamp through the recess of the open screw-cap in the quartz glass.

!! Attention!! Should the lamp break, the room must be vacated immediately and be well ventilated for at least 30 minutes. Subsequently, the glass can be disposed of.

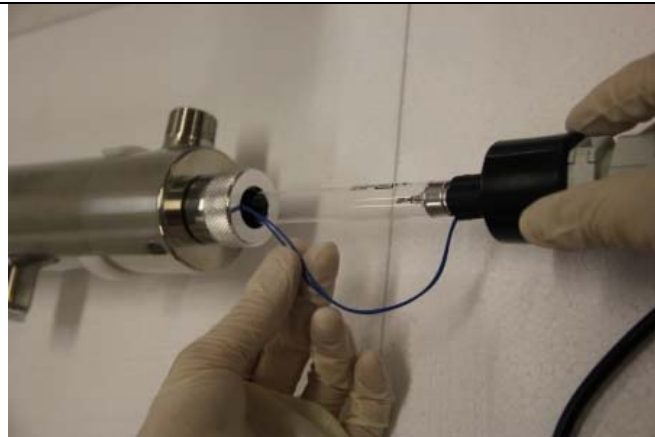

7.
Screw the cable fitting into the screw-cap and then fix the cable with the union nut on the cable fitting. Only now can the UV lamp be put into operation!



Note:

- Choose a convenient place for mounting (provide room for lamp replacement) and screw the system on the wall with the brackets. Connect the reactor to the water mains and check the system for leaks.
- The system can be installed horizontally or vertically. The outlet must be positioned in the highest position so that air can escape the system.

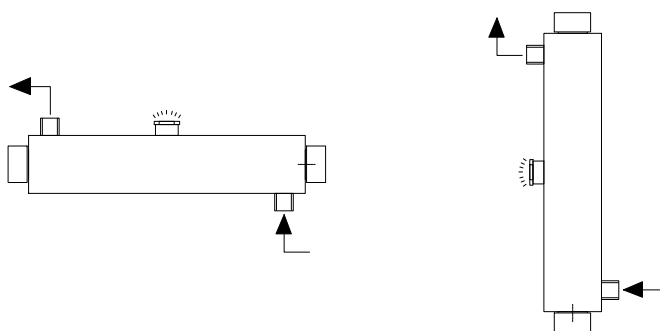

- With the UV-I-UNIT 110W system (2 x UV lamp) and the UV-I-UNIT 220W system (4 x UV lamp), the previous steps are performed for each lamp / quartz glass position.

7. Maintenance and Cleaning

We recommend cleaning the outside of the quartz glass and the reactor interior walls every 6 months. Depending on water quality, the cleaning interval can be extended.

The UV lamp must be replaced each year with continuous operation (= service life of 9000h).

Disassembly:



Before you begin the removal of the components, make sure that you disconnect the UV lamp from the power supply and drain the flow reactor!

Note that due to the expansion of the quartz glass, the lamp has to be removed first! Therefore follow the previously given order in reverse!

1.

Removal of UV lamp:

Loosen the union nut of the cable fitting (with wrench provided). Then loosen cable fitting and pull off the plastic cover of the screw-cap.

Attention!

Reactor, lamp and quartz glass can be hot! Let the components cool down if necessary!

Gently pull the UV lamp from the reactor.

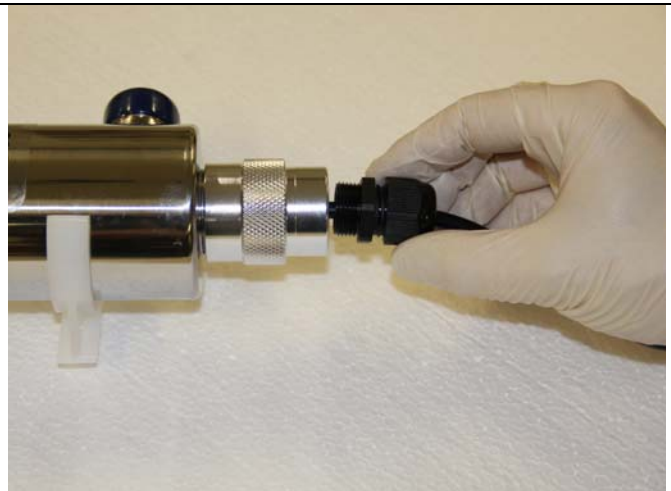

2.

Removal of quartz glass:

Remove the nut and the screw-cap with associated O-rings.

Pull the quartz glass from the open end carefully from the reactor. Make sure that no water gets into the glass (possibly protect with a cloth stopper before removal).

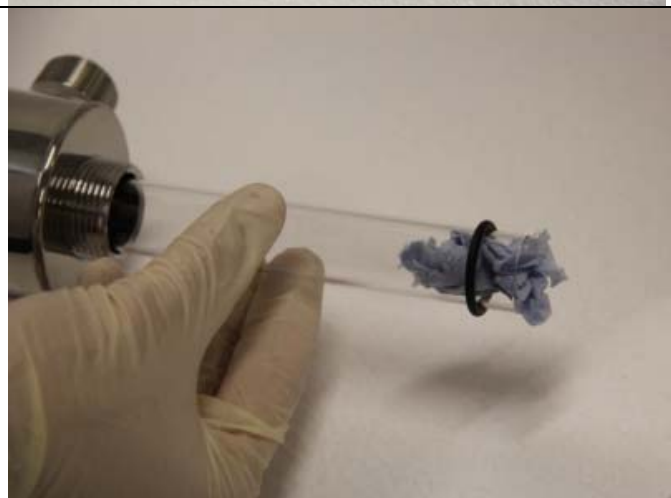

Now clean the quartz glass. Mineral deposits can be removed with a commercially available cleaning agent or citric acid.



The assembly of the service components is analogous to the described procedure "Chapter 6: Assembly Instructions".

8. Replacement Parts

Article description	Code	Art. No.
UV lamp 16W	UV-I-LAMP16W	240043
UV lamp 30W	UV-I-LAMP30W	240044
UV lamp 55W	UV-I-LAMP55W	240045
Quartz glass for UV unit 16W, incl. O-ring	UV-I-QUARZ-16W	240050
Quartz glass for UV unit 30 up to 220 W, incl. O-ring	UV-I-QUARZ-30W-220W	240055
Ballast for 16W UV unit	UV-I-BALLAST-16W	240060
Ballast for 30W UV unit	UV-I-BALLAST-30W	240062
Ballast for 55W UV unit	UV-I-BALLAST-55W	240064

9. Warranty / Contact

The warranty terms can be found in our sales conditions at:

<http://www.intewa.de/cs/dialog/rechtliches/verkaufsbedingungen>

For questions, ordering spare parts and in service cases, please call your dealer on the purchase receipt directly or visit the service area on the INTEWA website in your country.

www.intewa.com

